

NightForce

По вопросам продаж и поддержки обращайтесь:

Алматы (7273)495-231
Архангельск (8182)63-90-72
Астрахань (8512)99-46-04
Барнаул (3852)73-04-60
Белгород (4722)40-23-64
Брянск (4832)59-03-52
Владивосток (423)249-28-31
Волгоград (844)278-03-48
Вологда (8172)26-41-59
Воронеж (473)204-51-73
Екатеринбург (343)384-55-89
Иваново (4932)77-34-06
Ижевск (3412)26-03-58
Иркутск (395)279-98-46
Россия (495)268-04-70

Казань (843)206-01-48
Калининград (4012)72-03-81
Калуга (4842)92-23-67
Кемерово (3842)65-04-62
Киров (8332)68-02-04
Краснодар (861)203-40-90
Красноярск (391)204-63-61
Курск (4712)77-13-04
Липецк (4742)52-20-81
Магнитогорск (3519)55-03-13
Москва (495)268-04-70
Мурманск (8152)59-64-93
Набережные Челны (8552)20-53-41
Нижний Новгород (831)429-08-12
Киргизия (996)312-96-26-47

Новокузнецк (3843)20-46-81
Новосибирск (383)227-86-73
Омск (3812)21-46-40
Орел (4862)44-53-42
Оренбург (3532)37-68-04
Пенза (8412)22-31-16
Пермь (342)205-81-47
Ростов-на-Дону (863)308-18-15
Рязань (4912)46-61-64
Самара (846)206-03-16
Санкт-Петербург (812)309-46-40
Саратов (845)249-38-78
Севастополь (8692)22-31-93
Симферополь (3652)67-13-56
Казахстан (7172)727-132

Смоленск (4812)29-41-54
Сочи (862)225-72-31
Ставрополь (8652)20-65-13
Сургут (3462)77-98-35
Тверь (4822)63-31-35
Томск (3822)98-41-53
Тула (4872)74-02-29
Тюмень (3452)66-21-18
Ульяновск (8422)24-23-59
Уфа (347)229-48-12
Хабаровск (4212)92-98-04
Челябинск (351)202-03-61
Череповец (8202)49-02-64
Ярославль (4852)69-52-93



**30 YEARS
OF RUGGED,
RELIABLE,
REPEATABLE.**

“ I required a scope that was rugged, repeatable, and reliable. Something that could be beaten to death in the back of a ute in Outback Australia and still shoot a fox, at distance, at night.

Since no other optic manufacturer could fulfill my requirements, I decided to develop my own. Our first customers in the USA quickly appreciated the many unique features and benefits, which differentiated these products from our competition, and the rest sort of fell into place. ”

— Ray Dennis

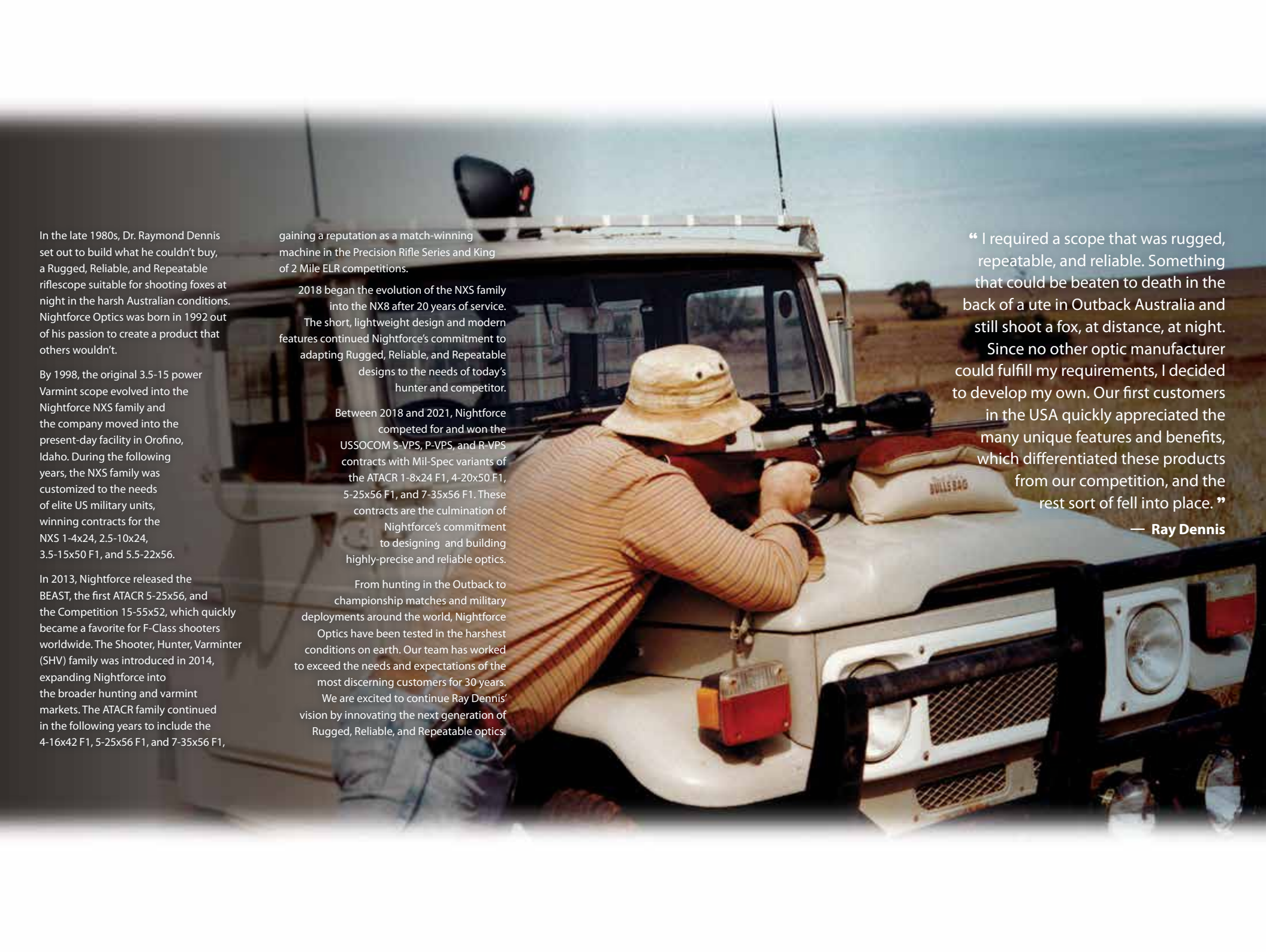

In the late 1980s, Dr. Raymond Dennis set out to build what he couldn't buy, a Rugged, Reliable, and Repeatable riflescope suitable for shooting foxes at night in the harsh Australian conditions. Nightforce Optics was born in 1992 out of his passion to create a product that others wouldn't.

By 1998, the original 3.5-15 power Varmint scope evolved into the Nightforce NXS family and the company moved into the present-day facility in Orofino, Idaho. During the following years, the NXS family was customized to the needs of elite US military units, winning contracts for the NXS 1-4x24, 2.5-10x24, 3.5-15x50 F1, and 5.5-22x56.

In 2013, Nightforce released the BEAST, the first ATACR 5-25x56, and the Competition 15-55x52, which quickly became a favorite for F-Class shooters worldwide. The Shooter, Hunter, Varminter (SHV) family was introduced in 2014, expanding Nightforce into the broader hunting and varmint markets. The ATACR family continued in the following years to include the 4-16x42 F1, 5-25x56 F1, and 7-35x56 F1,

gaining a reputation as a match-winning machine in the Precision Rifle Series and King of 2 Mile ELR competitions.

2018 began the evolution of the NXS family into the NX8 after 20 years of service. The short, lightweight design and modern features continued Nightforce's commitment to adapting Rugged, Reliable, and Repeatable designs to the needs of today's hunter and competitor.

Between 2018 and 2021, Nightforce competed for and won the USSOCOM S-VPS, P-VPS, and R-VPS contracts with Mil-Spec variants of the ATACR 1-8x24 F1, 4-20x50 F1, 5-25x56 F1, and 7-35x56 F1. These contracts are the culmination of Nightforce's commitment to designing and building highly-precise and reliable optics.

From hunting in the Outback to championship matches and military deployments around the world, Nightforce Optics have been tested in the harshest conditions on earth. Our team has worked to exceed the needs and expectations of the most discerning customers for 30 years.

We are excited to continue Ray Dennis' vision by innovating the next generation of Rugged, Reliable, and Repeatable optics.

“ I required a scope that was rugged, repeatable, and reliable. Something that could be beaten to death in the back of a ute in Outback Australia and still shoot a fox, at distance, at night. Since no other optic manufacturer could fulfill my requirements, I decided to develop my own. Our first customers in the USA quickly appreciated the many unique features and benefits, which differentiated these products from our competition, and the rest sort of fell into place. ”

— Ray Dennis

4-13 ATACR™ Riflescopes

- [6] ATACR™ 1-8 x 24 F1
- [7] ATACR™ 4-16 x 42 F1
- [8] ATACR™ 4-16 x 50
- [9] ATACR™ 4-20 x 50 F1
- [10] ATACR™ 5-25 x 56 F1
- [11] ATACR™ 5-25 x 56
- [12] ATACR™ 7-35 x 56 F1/F2

14-19 NX8™ Riflescopes

- [16] NX8™ 1-8 x 24 F1
- [18] NX8™ 2.5-20 x 50 F1/F2
- [19] NX8™ 4-32 x 50 F1/F2

20-25 NXS™ Riflescopes

- [22] NXS™ 2.5-10 x 42 Compact
- [23] NXS™ 3.5-15 x 50
- [24] NXS™ 5.5-22 x 50/56
- [25] NXS™ 8-32 x 56

26-31 SHV™ Riflescopes

- [28] SHV™ 3-10 x 42
- [29] SHV™ 4-14 x 50 F1
- [30] SHV™ 4-14 x 56
- [31] SHV™ 5-20 x 56

32-37 Competition™ and Precision Benchrest Riflescopes

- [34] Competition™ 15-55 x 52
- [35] Competition™ SR Fixed 4.5 x 24
- [36] Precision Benchrest 8-32 x 56
- [37] Precision Benchrest 12-42 x 56

38-45 Reticles**46-47 Nightforce Features****48-55 Accessories**

- [50] X-Treme Duty™ Rings & Bases
- [52] X-Treme Duty Unimount and Magmount
- [54] Nightforce Tool Kit & Cleaning Kit
- [55] Wedge Prism

56-59 Spotting Scopes and Accessories

- [58] TS-82™ Spotting Scopes
- [59] Spotting Scope Accessories

60-65 Apparel**66-67 Nightforce MIL-SPEC****68 Warranty & Customer Service****69 Contact Us****NEVER COMPROMISING QUALITY**

For three decades, our team has defined a standard of precision that only a trained human eye and experienced hands are sensitive enough to achieve. To this day, there is no such thing as “mass production” at Nightforce.

Before they leave the factory, Nightforce riflescopes are subjected to conditions far beyond anything you will likely encounter in the field. During our impact tests, riflescopes must endure repeated impacts of over 1200 Gs of force on multiple axes. After each severe impact, the riflescope is hand-checked for tracking accuracy and overall integrity. We rigorously test and inspect to ensure your Nightforce will work when you need it most.



ATACR™

Our Advanced Tactical Rifle Scope™ line is designed for, built for, and selected by the most discerning professional users from around the globe. ATACR riflescopes are trusted by the most revered military and law enforcement units and by those who desire professional performance from their equipment.

All ATACR™ riflescopes feature ED glass, which produces brilliant images, superb color contrast, and exceptional resolving power—allowing you to distinguish the smallest targets at extreme distances.

The mechanical features, optical quality, and durability of ATACR riflescopes provide tremendous capability in any application. They truly are an investment in a lifetime of accuracy and reliability.

ATACR™

1-8x24 F1

The ATACR™ 1-8x24 F1 delivers a high magnification range for an exceptionally versatile low-power optic. At close distances, the daylight-visible reticle illumination and true 1x magnification allow for rapid engagements similar to a red dot sight. When the target distance increases, our 1-8x magnification range allows you to detect, recognize, identify, and engage targets at ranges far beyond a traditional red dot sight. Just over 10 inches in length and only 21 ounces, with low-profile turrets, it is a significant upgrade to any rifle system.



Magnification range	1-8x	Eye relief	3.7 in/95 mm
Focal plane	First	Field of view @ 100 yd/m	1x: 96.1 ft/32.0 m 8x: 13.1 ft/4.4 m
Body tube diameter	34 mm	Exit pupil	1x: 11.3 mm 8x: 3.2 mm
Overall length	10.1in/256 mm	Illumination	Daylight visible, externally adjustable, two night vision compatible settings
Mounting length	5.7 in/144 mm	Elevation feature	Capped, finger adjustable
Weight	21.0 oz/595 g	Power Throw Lever	Standard
Click value	.1 MRAD	Reticles available	FC-DMX™
Internal adjustment range	E: 30 MRAD W: 30 MRAD		
Parallax adjustment	Fixed @ 125 m		

ATACR™

4-16x42 F1

The ATACR™ 4-16x42 F1 was created to maximize the potential of precision semi-automatic rifles—a need identified by military and civilian shooters. The ZeroHold feature holds the turret at zero and is designed for rapid target engagement with holdover reticles such as the Horus TREMOR3™ or the Mil-XT. At 12.6 inches long and 30 ounces, the small footprint leaves ample room for weapon mounted rangefinders, clip-on enablers, and anything else needed to accomplish your mission.

ZeroHold Digillum

Magnification range	4-16x	Eye relief	3.5 in/90 mm
Focal plane	First	Field of view @ 100 yd/m	4x: 26.9 ft/9.0 m 16x: 6.9 ft/2.3 m
Body tube diameter	34 mm	Exit pupil	4x: 10.3 mm 16x: 2.7 mm
Overall length	12.6 in/320 mm	Illumination	Digillum™
Mounting length	6.3 in/160 mm	Elevation feature	ZeroHold®
Weight	30.0 oz/850 g	Power Throw Lever	Standard
Click value	.250 MOA or .1 MRAD	Reticles available	MOAR™ MIL-C™ MIL-R™ MIL-XT™ H-59™ TREMOR3™
Internal adjustment range	E: 89 MOA/26 MRAD W: 60 MOA/18 MRAD		
Parallax adjustment	45 yd-∞		

ATACR™

4-16x50

The ATACR™ 4-16x50 delivers superb low-light performance, ED glass and extensive elevation adjustment, housed in a riflescope impervious to recoil from the largest calibers. Hunters and Law Enforcement frequently opt for second focal plane riflescopes due to the consistent size and highly visible reticle that is beneficial for rapid but critical shots at lower magnification.

Whether counting the points of a trophy buck or distinguishing friend from foe, the ATACR 4-16x50 has the resolution and clarity to excel in either role.

ZeroStop **Digillum**

Magnification range	4-16x	Eye relief	3.5 in/89 mm
Focal plane	Second	Field of view @ 100 yd/m	4x: 26.9 ft/9.0 m 16x: 6.9 ft/2.3 m
Body tube diameter	34 mm	Exit pupil	4x: 9.5 mm 16x: 3.2 mm
Overall length	13.1 in/333 mm	Illumination	Digillum™
Mounting length	6.3 in/161 mm	Elevation feature	ZeroStop®
Weight	33.3 oz/944 g	Power Throw Lever	Standard
Click value	.250 MOA or .1 MRAD	Reticles available	MOAR™ MIL-R™
Internal adjustment range	E: 110 MOA/30 MRAD W: 60 MOA/16 MRAD		
Parallax adjustment	45 yd-∞		

ATACR™

4-20x50 F1

The 4-20x50 F1 fills an important magnification range in the ATACR™ line. Equally at home atop a bolt action or a semi-automatic rifle, the 4-20x50 F1 is smaller and lighter than the 5-25x56 F1 while offering a 25% improvement in magnification over the 4-16x42 F1. With Digillum, a ZeroStop turret, power throw lever, ED lenses, and 20x max magnification, the ATACR 4-20x50 F1 is our apex mid-power scope.

ZeroStop **Digillum**

Magnification range	4-20x	Eye relief	3.5 in/90 mm
Focal plane	First	Field of view @ 100 yd/m	4x: 23.6 ft/7.9 m 20x: 6.1 ft/2.0 m
Body tube diameter	34 mm	Exit pupil	4x: 8.3 mm 20x: 2.5 mm
Overall length	13.9 in/353 mm	Illumination	Digillum™
Mounting length	5.9 in/150 mm	Elevation feature	ZeroStop®
Weight	35.2 oz/998 g	Power Throw Lever	Standard
Click value	.250 MOA or .1 MRAD	Reticles available	MOAR™ MIL-C™ MIL-XT™ TREMOR3™
Internal adjustment range	E: 130 MOA/38 MRAD W: 100 MOA/29 MRAD		
Parallax adjustment	11 yd-∞		

ATACR™

5-25x56 F1

The ATACR™ 5-25x56 F1's use of ED glass produces images of striking brilliance and clarity. First focal plane technology means consistent reticle values, regardless of magnification setting. A wide range of both MOA and MRAD reticle options provides the perfect reticle for any use. A massive 120 MOA/35 MRAD of elevation adjustment complements today's high-BC, long range cartridges to reach targets previously thought to be out of range.

ZeroStop® Digillum™

Magnification range	5-25x	Eye relief	3.5 in/90 mm
Focal plane	First	Field of view @ 100 yd/m	5x: 18.7 ft/6.2 m 25x: 4.9 ft/1.6 m
Body tube diameter	34 mm	Exit pupil	5x: 8.3 mm 25x: 2.3 mm
Overall length	15.4 in/390 mm	Illumination	Digillum™
Mounting length	5.9 in/150 mm	Elevation feature	ZeroStop®
Weight	37.6 oz/1066 g	Power Throw Lever	Standard
Click value	.250 MOA or .1 MRAD	Reticles available	MOAR™ MIL-C™ MIL-R™ MIL-X™ H-59™ TREMOR3™
Internal adjustment range	E: 120 MOA/35 MRAD W: 80 MOA/24 MRAD		
Parallax adjustment	45 yd-∞		

ATACR™

5-25x56

The ATACR™ 5-25x56 will exceed the potential of the flattest-shooting cartridges and high ballistic coefficient projectiles. Multiple second focal plane reticles tailored in design for hunting and target shooting ensure a crisp and consistent target view. Like all ATACR riflescopes, the ED glass provides extraordinary resolution and brilliant images at all distances.

ZeroStop® Digillum™

Magnification range	5-25x	Eye relief	3.5 in/90 mm
Focal plane	Second	Field of view @ 100 yd/m	5x: 18.0 ft/6.0 m 25x: 4.9 ft/1.6 m
Body tube diameter	34 mm	Exit pupil	5x: 10.5 mm 25x: 2.2 mm
Overall length	14.3 in/363 mm	Illumination	Digillum™
Mounting length	6.1 in/156 mm	Elevation feature	ZeroStop®
Weight	39.1 oz/1108 g	Power Throw Lever	Standard
Click value	.250 MOA or .1 MRAD	Reticles available	MOAR™ MOAR-T™ MIL-R™
Internal adjustment range	E: 120 MOA/35 MRAD W: 60 MOA/17 MRAD		
Parallax adjustment	45 yd-∞		

ATACR™

7-35x56 F1/F2

If the mission requires the most magnification and razor-sharp images at any power then the ATACR™ 7-35x56 is the ideal choice. Over 100 MOA/29 MRAD of travel and parallax that can focus at just 11 yards allows for use on rimfire and air rifles up to the largest extreme long range rifles.

Whether choosing F1 or F2, a variety of reticle options ensure a perfect choice for any application you have for the highly versatile ATACR 7-35x56.

ZeroStop
DigiIllum



Magnification range	7-35x	Field of view @ 100 yd/m	7x: 15.0 ft/5.0 m 35x: 3.4 ft/1.1 m
Focal plane	First / Second	Exit pupil	7x: 6.0 mm 35x: 1.6 mm
Body tube diameter	34 mm	Illumination	DigiIllum™
Overall length	16.0 in/406 mm	Elevation feature	ZeroStop®
Mounting length	6.6 in/167 mm	Power Throw Lever	Standard
Weight	39.3 oz/1113 g	Reticles available / F1	MOAR™ MIL-C™ MIL-R™ MIL-XT™ H-59™ TREMOR3™
Click value	.250 MOA or .1 MRAD	Reticles available / F2	MOAR-T™ MIL-C™
Internal adjustment range	E: 100 MOA/29 MRAD W: 60 MOA/17 MRAD		
Parallax adjustment	11 yd-∞		
Eye relief / F1	3.6 in/91 mm		
Eye relief / F2	3.5 in/89 mm		



The background image shows two hunters in camouflage gear standing on a snowy mountain ridge. The hunter on the left is carrying a large pack and holding a rifle with large antlers. The hunter on the right is also carrying a pack and holding a rifle. The scene is set in a mountainous, snowy landscape under a clear blue sky.

NX8™

The NX8™ family of riflescopes evolved from our classic NX5™ series—scopes proven over two decades in the hands of the U.S. Military, hunters and competitive shooters under the most demanding conditions on earth. NX8™ riflescopes build upon this hard-earned reputation. The NX8 family was designed to provide excellent optical performance throughout the remarkable 8x magnification range in the most compact and capable package possible. To achieve this, our optical designers chose to utilize ED glass elements in these designs, which allow for a short optical path while maintaining optical clarity.

Available in magnification ranges from 1-8x to 4-32x in both first and second focal plane models, the NX8 family has an optic that is sure to bring incredible capability to your favorite rifle.

NX8™

1-8x24 F1

At 8.75 inches in length and 17.6 ounces, the NX8 1-8x24 F1 is a capable addition to any carbine or featherweight rifle. The 8x magnification range provides the versatility needed for short to medium-range shooting.

The daylight visible reticle illumination and true 1x magnification allow the shooter to engage near targets with the speed of a red dot sight.

As the target range increases, the first focal plane reticle provides precise holds and a detailed view of the target.



Magnification range	1-8x	Eye relief	3.7 in/95 mm
Focal plane	First	Field of view @ 100 yd/m	1x: 106.0 ft/35.3 m 8x: 13.2 ft/4.4 m
Body tube diameter	30 mm	Exit pupil	1x: 7.9 mm 8x: 3.0 mm
Overall length	8.7 in/222 mm	Illumination	Daylight visible, externally adjustable
Mounting length	5.7 in/144 mm	Elevation feature	ZeroStop®
Weight	17.6 oz/499 g	Power Throw Lever	Standard
Click value	.500 MOA or .2 MRAD	Reticles available	FC-MOA™ FC-MIL™
Internal adjustment range	E: 100 MOA/30 MRAD W: 100 MOA/30 MRAD		
Parallax adjustment	Fixed @ 125 m		



NX8™

2.5-20x50 F1/F2

The NX8™ 2.5-20x50 provides a versatile magnification range for most hunters and shooters. At only 12 inches in length, the 2.5-20x50 includes a ZeroStop turret and Digillum in this compact package. Both F1 and F2 models are available in MOA and MRAD reticles to suit the endless uses you may find for this optic.

ZeroStop **Digillum**

Magnification range	2.5-20x	Field of view @ 100 yd/m / F2	2.5x: 36.7 ft/12.2 m 20x: 6.1 ft/2.0 m
Focal plane	First / Second	Exit pupil / F1	2.5x: 7.1 mm 20x: 2.5 mm
Body tube diameter	30 mm	Exit pupil / F2	2.5x: 5.9 mm 20x: 2.5 mm
Overall length / F1	12.0 in/305 mm	Illumination	Digillum™
Overall length / F2	12.1 in/308 mm	Elevation feature	ZeroStop®
Mounting length	5.4 in/138 mm	Power Throw Lever	Standard
Weight / F1	28.3oz/802g	Reticles available / F1	MOAR™ MIL-C™ MIL-XT™ TREMOR3™
Weight / F2	28.6oz/811g	Reticles available / F2	MOAR-CF2™ MIL-CF2™
Click value	.250 MOA or .1 MRAD		
Internal adjustment range	E: 110 MOA/32 MRAD W: 80 MOA/23 MRAD		
Parallax adjustment	11 yd-∞		
Eye relief	3.5 in/88 mm		
Field of view @ 100 yd/m / F1	2.5x: 41.8 ft/13.9 m 20x: 7.0 ft/2.3 m		

NX8™

4-32x50 F1/F2

The NX8™ 4-32x50 provides a large magnification range that tops out at an impressive 32x. Available with multiple MOA and MRAD reticles in first or second focal plane versions, there is an NX8 4-32x available to suit nearly any shooting style or use. In F2 models, the dual scale reticle system provides reticle numbering at both 16x and 32x to allow for accurate subtensions with either a wide field of view or maximum detail as needed.

ZeroStop **Digillum**

Magnification range	4-32x	Field of view @ 100 yd/m / F2	4x: 26.0 ft/8.7 m 32x: 4.6 ft/1.5 m
Focal plane	First / Second	Exit pupil / F1	4x: 7.3 mm 32x: 1.6 mm
Body tube diameter	30 mm	Exit pupil / F2	4x: 6.7 mm 32x: 1.6 mm
Overall length / F1	13.4 in/340 mm	Illumination	Digillum™
Overall length / F2	13.5 in/343 mm	Elevation feature	ZeroStop®
Mounting length	5.7 in/145 mm	Power Throw Lever	Standard
Weight / F1	28.6 oz/811 g	Reticles available / F1	MOAR™ MIL-C™ MIL-XT™ TREMOR3™
Weight / F2	28.9 oz/819 g	Reticles available / F2	MOAR-CF2D™ MIL-CF2D™
Click value	.250 MOA or .1 MRAD		
Internal adjustment range	E: 90 MOA/26 MRAD W: 70 MOA/20 MRAD		
Parallax adjustment	11 yd-∞		
Eye relief	3.5 in/88 mm		
Field of view @ 100 yd/m / F1	4x: 26.1 ft/8.7 m 32x: 4.6 ft/1.5 m		



NXS

For over 20 years, Nightforce NXS™ riflescopes have defined Rugged, Reliable, Repeatable by performing impeccably in the most brutal, unforgiving environments on earth. NXS™ riflescopes are still trusted in combat, on duty, and on trophy hunts throughout the world. The NXS laid the foundation of our design philosophy that we built upon for our ATACR and NX8 product lines.

The battery of tests Nightforce developed to ensure the ruggedness of the NXS™ riflescopes became the standard by which all Nightforce riflescopes are tested. This includes the side and front impact - a test that would destroy ordinary optics.

The NXS™ family is a legend to Nightforce and that legend lives on in all our products.



2.5-10x42

At 11.9 inches in length and 20.5 ounces in weight, the NXS™ 2.5-10x42 is compact, lightweight, and capable. This scope is at home on a lightweight mountain rifle, fast-handling big bore safari rifle, or on a precision focused AR-15/AR-10.

With a ZeroStop™ elevation turret, side parallax adjustment, and Digillum™ reticle illumination, this scope offers a lot of capability in a package that won't weigh your rifle down.

ZeroStop[®] Digillum[™]



Magnification range	2.5-10x	Eye relief	3.3 in/85 mm
Focal plane	Second	Field of view @ 100 yd/m	2.5x: 44.0 ft/14.7 m 10x: 11.0 ft/3.7m
Body tube diameter	30 mm	Exit pupil	2.5x: 15.5 mm 10x: 4.4 mm
Overall length	11.9 in/302 mm	Illumination	Digillum™
Mounting length	5.1 in/130 mm	Elevation feature	ZeroStop®
Weight	20.5 oz/581 g	Power Throw Lever	Standard
Click value	.250 MOA or .1 MRAD	Reticles available	MOAR™ MIL-R™
Internal adjustment range	E: 100 MOA/29 MRAD W: 100 MOA/29 MRAD		
Parallax adjustment	25 yd-∞		



3.5-15x50

A Nightforce classic, the NXS™ 3.5-15x50 is a favorite on duty and on the most demanding hunts around the world. The 3.5-15x magnification range adapts to a variety of rifle platforms and the ZeroStop turret and illumination allow for accurate shots in varying light conditions. Most importantly, the design, production, and testing processes pioneered on the NXS™ 3.5-15x50 is why Nightforce scopes proudly have the reputation of being "Just About Bulletproof".

ZeroStop[®]



Magnification range	3.5-15x	Eye relief	3.9 in/99 mm
Focal plane	Second	Field of view @ 100 yd/m	3.5x: 27.6 ft/9.2 m 15x: 7.3 ft/2.4 m
Body tube diameter	30 mm	Exit pupil	3.5x: 14.3 mm 15x: 3.6 mm
Overall length	14.7 in/373 mm	Illumination	Analog
Mounting length	6.1 in/155 mm	Elevation feature	ZeroStop®
Weight	30.0 oz/850 g	Power Throw Lever	Accessory
Click value	.250 MOA	Reticles available	MOAR™
Internal adjustment range	E: 110 MOA W: 80 MOA		
Parallax adjustment	50 yd-∞		



5.5-22x50/56

The NXS™ 5.5-22x is a combat-proven favorite of sportsmen and long-range shooters everywhere. Both models provide excellent eye relief, a ZeroStop elevation turret, and 100 MOA of elevation travel. Available in both the popular MOAR and the finer MOAR-T reticles, the NXS 22x riflescopes provide a high-resolution view of both the target and the reticle.



Magnification range	5.5-22x	Eye relief / 22x50	3.7 in/95 mm
Focal plane	Second	Eye relief / 22x56	3.9 in/99 mm
Body tube diameter	30 mm	Field of view @ 100 yd/m	5.5x: 17.5 ft/5.8 m 22x: 4.7 ft/1.6 m
Overall length / 22x50	15.1 in/384 mm	Exit pupil / 22x50	5.5x: 9.1 mm 22x: 2.3 mm
Overall length / 22x56	15.2 in/385 mm	Exit pupil / 22x56	5.5x: 10.2 mm 22x: 2.5 mm
Mounting length	6.6 in/168 mm	Illumination	Analog
Weight / 22 x50	31.0 oz/879 g	Elevation feature	ZeroStop®
Weight / 22x56	32.0 oz/907 g	Power Throw Lever	Accessory
Click value	.250 MOA	Reticles available	MOAR™ MOAR-T™
Internal adjustment range	E: 100 MOA W: 60 MOA		
Parallax adjustment	50 yd-∞		



8-32x56

The NXS™ 8-32x56 provides the extra-magnification that hunters and many competitors need. It has been the choice of dozens of winners of the most demanding, prestigious competitions in the world, including several Wimbledon Cups. With legendary Nightforce construction, the rugged and reliable NXS™ 8-32x56 will be a trusted companion for a lifetime of competitions and hunts.



Magnification range	8-32x	Eye relief	3.9 in/98 mm
Focal plane	Second	Field of view @ 100 yd/m	8x: 12.1 ft/4.0 m 32x: 3.1 ft/1.0 m
Body tube diameter	30 mm	Exit pupil	8x: 7.0 mm 32x: 1.8 mm
Overall length	15.9 in/404 mm	Illumination	Analog
Mounting length	6.7 in/170 mm	Elevation feature	ZeroStop®
Weight	34.0 oz/964 g	Power Throw Lever	Accessory
Click value	.250 MOA	Reticles available	MOAR™ MOAR-T™
Internal adjustment range	E: 65 MOA W: 45 MOA		
Parallax adjustment	50 yd-∞		



Nightforce Shooter, Hunter, Varminter, SHV™, riflescopes are designed for maximum versatility across a wide range of shooting disciplines. Whether you enjoy target shooting, pursuing big game, varmint shooting, or all of the above, there is an SHV™ designed for you.

The SHV™ line was specifically designed for hunters and shooters who want Nightforce quality and don't need all the features of our NX8™ and ATACR™ lines. Our Rugged, Reliable, Repeatable promise means that the SHV will outperform many optics and brands that cost much more.



3-10x42

The SHV™ 3-10x42 is a compact and lightweight choice for your rimfire, lever-action, or hunting rifle. An easily adjusted, rotary illumination ensures the reticle is clearly visible in any lighting condition.

Whether your target is squirrel, boar, or buffalo, the SHV™ 3-10x42 provides a bright, crisp image, excellent resolution, and reliable performance.



Magnification range	3-10x	Eye relief	3.5 in/88 mm
Focal plane	Second	Field of view @ 100 yd/m	3x: 34.9 ft/11.6 m 10x: 11.0 ft/3.7 m
Body tube diameter	30 mm	Exit pupil	3x: 10.7 mm 10x: 4.4 mm
Overall length	11.6 in/295 mm	Illumination	Analog
Mounting length	5.1 in/130 mm	Elevation feature	Capped, finger adjustable
Weight	22.2 oz/629 g	Power Throw Lever	Accessory
Click value	.250 MOA	Reticles available	MOAR™ Forceplex™ (N. Amer.) 4A (Int'l only)
Internal adjustment range	E: 90 MOA W: 80 MOA		
Parallax adjustment	Fixed @ 125 yd		



4-14x50 F1

Those who prefer the advantages of first focal plane reticle placement have a winner in our SHV™ 4-14x50 F1. The exposed ZeroSet elevation turret, in either .250 MOA or .1 Mil-Radian increments, is standard as is a center-illuminated reticle. The versatility, optical quality, and mechanical durability of the 4-14x50 F1 SHV are sure to reward you for years to come.



Magnification range	4-14x	Eye relief	3.1 in/80 mm
Focal plane	First	Field of view @ 100 yd/m	4x: 25.1 ft/8.4 m 14x: 7.4 ft/2.5 m
Body tube diameter	30 mm	Exit pupil	4x: 10.8 mm 14x: 3.3 mm
Overall length	14.8 in/376 mm	Illumination	Analog
Mounting length	6.1 in/155 mm	Elevation feature	ZeroSet™
Weight	30.0 oz/850 g	Power Throw Lever	Accessory
Click value	.250 MOA or .1 MRAD	Reticles available	MOAR™ MIL-R™
Internal adjustment range	E: 90 MOA/27 MRAD W: 70 MOA/19 MRAD		
Parallax adjustment	25 yd-∞		



4-14x56

The SHV™ 4-14x56 remains one of the most versatile riflescopes we make. Equally efficient in putting small groups on paper at long ranges, or matched with a powerful, flat-shooting rifle for big game most anywhere on earth.

It certainly isn't short on features with side parallax control, a choice of illuminated and non-illuminated reticles, and clarity, brightness, and resolution you must see to appreciate.



Magnification range	4-14x	Eye relief	3.6 in/92 mm
Focal plane	Second	Field of view @ 100 yd/m	4x: 24.9 ft/8.3 m 14x: 7.3 ft/2.2 m
Body tube diameter	30 mm	Exit pupil	4x: 12.0 mm 14x: 3.6 mm
Overall length	14.8 in/376 mm	Illumination	Analog (Optional)
Mounting length	5.8 in/147 mm	Elevation feature	Capped, finger adjustable
Weight	26.9 oz/763 g (non-illum) 28.5 oz/808 g (illum)	Power Throw Lever	Accessory
Click value	.250 MOA	Reticles available	MOAR™ 4A (Int'l only)
Internal adjustment range	E: 90 MOA W: 70 MOA		
Parallax adjustment	25 yd-∞		



5-20x56

The SHV™ 5-20x56 is the most powerful of our SHV™ series performing beautifully at both close and extended ranges.

It offers outstanding clarity, crispness and color contrast at every magnification setting. It also features a full 80 MOA of elevation adjustment, side parallax adjustment, and the ZeroSet™ elevation turret, which allows a quick return to your initial zero setting, regardless of how many elevation adjustments you've made.



Magnification range	5-20x	Eye relief	3.5 in/90 mm
Focal plane	Second	Field of view @ 100 yd/m	5x: 17.9 ft/6.0 m 20x: 5.0 ft/1.7 m
Body tube diameter	30 mm	Exit pupil	5x: 8.7 mm 20x: 2.5 mm
Overall length	15.2 in/386 mm	Illumination	Analog (Optional)
Mounting length	6.5 in/165 mm	Elevation feature	ZeroSet™
Weight	29.1 oz/825 g (non-illum) 30.5 oz/865 g (illum)	Power Throw Lever	Accessory
Click value	.250 MOA	Reticles available	MOAR™ Forceplex™ (N. Amer.) 4A (Int'l only)
Internal adjustment range	E: 80 MOA W: 50 MOA		
Parallax adjustment	25 yd-∞		



COMPETITION™

PRECISION BENCHREST

As rifle shooting competitions become ever-more demanding, we identified the need for a new class of riflescopes capable of maximum precision at any distance. Our relationships with top shooters and teams have led to tailor-made riflescopes used to set records and win world championships. This is our Competition™ family.

Competition™ riflescopes are purpose-built for the competitive shooter. They are not double-duty or modified optics with a fancy name applied.

All Competition™ and Precision Benchrest riflescopes are carefully matched with our own unique reticles, developed over decades of experience and with input from record-setting shooters, created specifically to complement the extraordinary ability of these riflescopes.



Nightforce is proud to be a long-time supporter of the U.S. F-Class rifle teams and other competitive teams throughout the world.

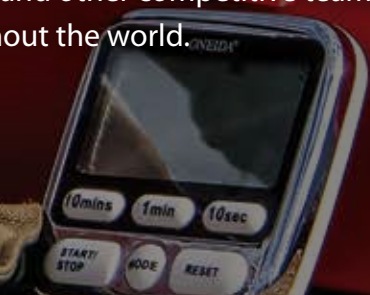



15-55x52

The Competition™ 15-55x52 continues to set new standards for long-range performance.

The U.S., Australian and South African F-Class rifle teams praise its exceptional clarity and resolving power. Its robust construction allows the 15-55x52 to digest thousands of rounds and always respond like new.

Many professional shooters have labeled it, "the perfect F-Class riflescope." We'll let you and your scores, be the judges.



Magnification range	15-55x	Eye relief	3.2 in/81 mm
Focal plane	Second	Field of view @ 100 yd/m	15x: 6.9 ft/2.3 m 55x: 1.8 ft/0.6 m
Body tube diameter	30 mm	Exit pupil	15x: 3.5 mm 55x: 0.9 mm
Overall length	16.2 in/411 mm	Illumination	Non-illuminated
Mounting length	6.4 in/162 mm	Elevation feature	ZeroStop®
Weight	27.9 oz/790 g	Power Throw Lever	N/A
Click value	.125 MOA	Reticles available	CTR-2™ CTR-3™ DDR-2™ FCR-1™
Internal adjustment range	E: 55 MOA W: 50 MOA		
Parallax adjustment	25 yd-∞		



SR FIXED 4.5x24

The Competition™ SR Fixed 4.5x24 was created to dominate service rifle matches held under both Civilian Marksmanship Program (CMP) and NRA rules and it has. The Comp SR 4.5x24 has been used to set new national records and achieve perfect scores in High Power and President's 100 competitions.

This riflescope complies with match rules that allow the use of riflescopes having a maximum magnification of 4.5x and an objective lens of 34mm or less. It is compact, lightweight, and repeatable over a lifetime of hard use.



Magnification range	4.5x	Eye relief	3.7 in/95 mm
Focal plane	Second	Field of view @ 100 yd/m	23.2 ft/7.7 m
Body tube diameter	30 mm	Exit pupil	5.3 mm
Overall length	9.9 in/251 mm	Illumination	Non-illuminated
Mounting length	6.6 in /168 mm	Elevation feature	ZeroStop®
Weight	15.4 oz/437 g	Power Throw Lever	N/A
Click value	.250 MOA	Reticles available	SR-2™
Internal adjustment range	E: 100 MOA W: 100 MOA		
Parallax adjustment	Fixed @ 200 yds		

PRECISION BENCHREST

8-32x56

For over 25 years, the Precision Benchrest riflescopes have been a favorite of competition target shooters. The large, 56mm objective with adjustable objective parallax allows precise adjustment and a clear, high-resolution target image. The illumination control allows the brightness of the fine reticles to be adjusted based on light and target color.

The Precision Benchrest 8-32x56 is most popular for Short Range Benchrest and Silhouette shooting.



Magnification range	8-32x	Eye relief	3.0 in/75 mm
Focal plane	Second	Field of view @ 100 yd/m	8x: 9.4 ft/3.1 m 32x: 3.1 ft/1.0 m
Body tube diameter	30 mm	Exit pupil	8x: 5.6 mm 32x: 1.7 mm
Overall length	16.6 in/422 mm	Illumination	Analog
Mounting length	5.5 in/140 mm	Elevation feature	Capped, finger adjustable
Weight	36.0 oz/1021 g	Power Throw Lever	N/A
Click value	.125 MOA	Reticles available	NP-R2™
Internal adjustment range	E: 50 MOA W: 50 MOA		
Parallax adjustment	25 yd-∞		

PRECISION BENCHREST

12-42x56

The Precision Benchrest riflescopes have remained virtually unchanged since we first introduced them over 25 years ago. The 1/8 MOA target turrets and purpose-built target reticles are a time-tested favorite of benchrest competitors. As a favorite of .50 BMG shooters, their ruggedness is beyond question.

The Precision Benchrest 12-42x56 is most popular for Long Range Benchrest and F-Class shooting.



Magnification range	12-42x	Eye relief	3.0 in/75 mm
Focal plane	Second	Field of view @ 100 yd/m	12x: 6.7 ft/2.2 m 42x: 2.3 ft/0.8 m
Body tube diameter	30 mm	Exit pupil	12x: 4.0 mm 42x: 1.4 mm
Overall length	17.0 in/432 mm	Illumination	Analog
Mounting length	5.9 in/150 mm	Elevation feature	Capped, finger adjustable
Weight	36.0 oz/1021 g	Power Throw Lever	N/A
Click value	.125 MOA	Reticles available	NP-R2™ NP-2DD™
Internal adjustment range	E: 40 MOA W: 40 MOA		
Parallax adjustment	25 yd-∞		

RETICLES

Choosing a reticle is often the most challenging part of a riflescope purchase. Reticles define how shooters interact with the target, making the selection both personal and an important factor in how well the riflescope performs in their specific application.

The team at Nightforce is made up of experienced hunters and shooters who are passionate about offering reticles that are functional and purpose built. With options in F1 and F2, Minute of Angle (MOA) and Mil-Radian (MRAD), there is a Nightforce reticle available for nearly every imaginable use.



MINUTE OF ANGLE

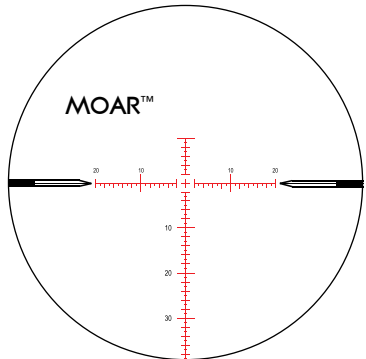

Our most popular MOA-based reticle. Intelligent and highly versatile across almost any shooting application.

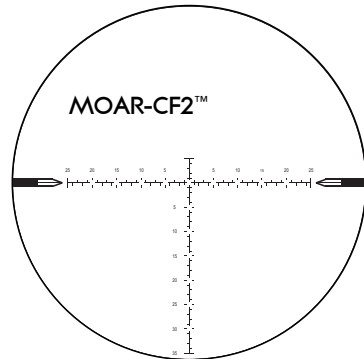

An evolution of our most popular MOAR reticle. The open center with floating dot and intuitive numbering allows for fast shooting whether dialing or holding over.

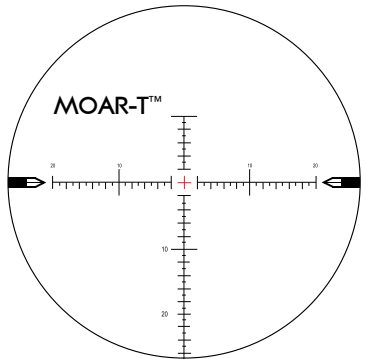

A finer version of our MOAR™, allowing even greater precision at close or extreme ranges.

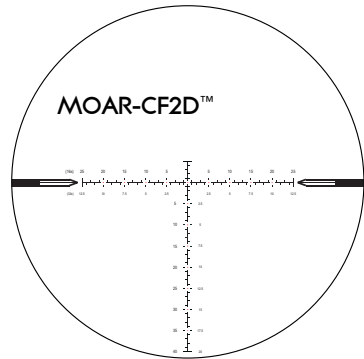

A Dual Scale version of our MOAR-CF2 reticle. Specifically designed for use at 16x and 32x on the NX8 4-32x50.

Minute of Angle Explained

A true MOA is equal to one-sixtieth of one degree, which is 1.047" at 100 yards.

As an angular unit of measurement, the value is not an equal, linear amount at all distances. As such, 1 MOA is 1.047" at 100 yards, 2.094" at 200 yards, 3.141" at 300 yards, etc.

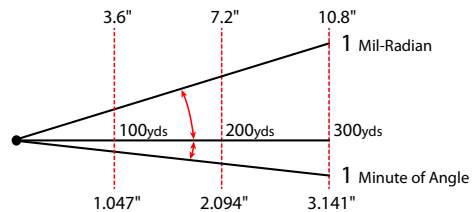

MIL-RADIAN

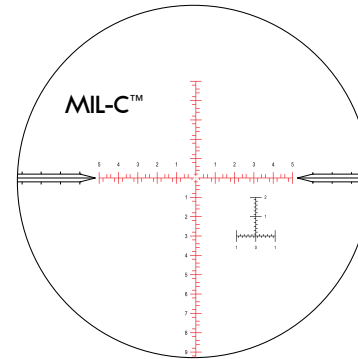

Designed for the Precision Rifle Series competitor and field shooters. Fast and accurate, superb range finding capabilities.

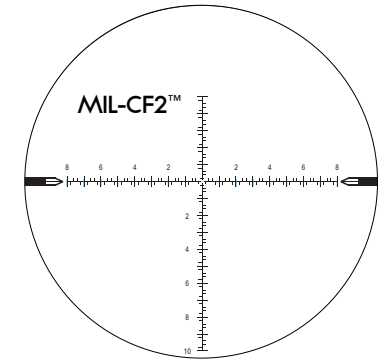

An F2 variant of our popular MIL-C reticle. The more simplified view allows for an uncluttered and open view of the target popular with F2 shooters.

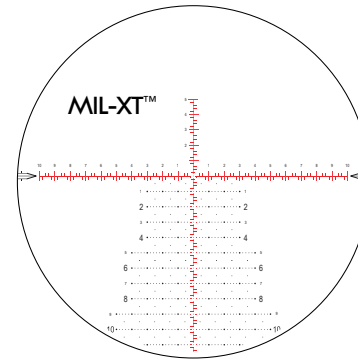

An evolution of the MIL-C™, adding extra hold-over and hold-off markings for rapid target engagements.

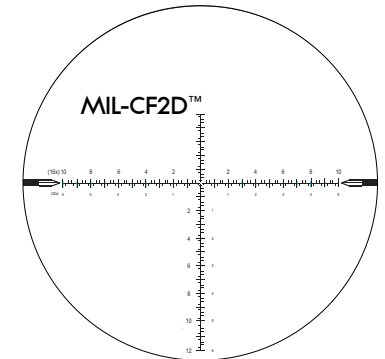

A Dual Scale version of our MIL-CF2 reticle. Specifically designed for use at 16x and 32x on the NX8 4-32x50.

Mil-Radian Explained

The incremental amount denoted as a Mil-Radian (Mil) is an angular system of measurement. A true Mil is equal to 1/6283 of a circle, or 3.43775 MOA. This equals 3.600" at 100 yards or 10 cm at 100 meters.

As an angular unit of measurement, the value is not an equal, linear amount at all distances. As such, 1 Mil is 3.600" at 100 yards, 7.200" at 200 yards, 10.800" at 300 yards, etc.

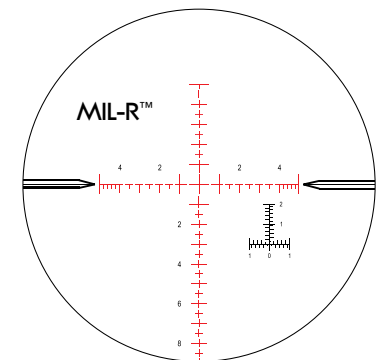

Clean and uncluttered, designed for speed and intuitive shooting, providing precision ranging, accurate hold-offs and quick followup shots.

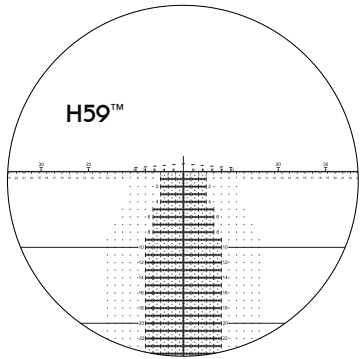

A rapid engagement reticle with multiple hold points and the Accuracy 1st Speed Shooting Formula built in.

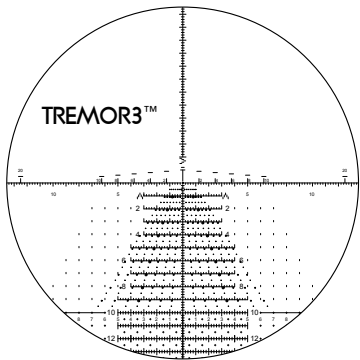

Designed for speed at any distance. Especially helpful in windy conditions. The Accuracy 1st Speed Shooting Formula is built in.

H59 and TREMOR3™ are trademarks of Horus Vision. Reticle designs © Horus Vision 2022, all rights reserved.

LOW POWER

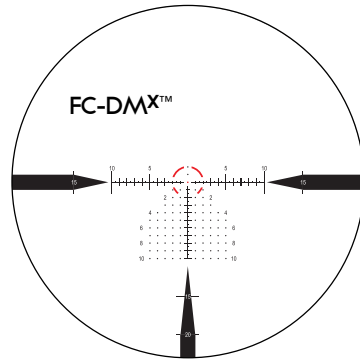

Optimized for low power variable riflescopes with first focal plane reticles. The daylight visible illumination and aiming dot system allow for fast and precise target engagements at close and extended distances.

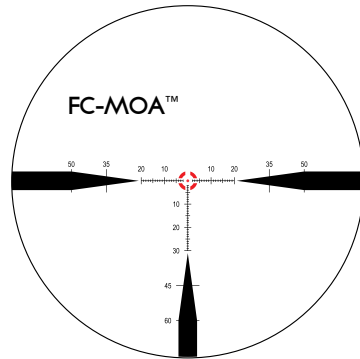

FC-MOA and FC-MIL were created and optimized for our low-power variable riflescopes. As first focal plane reticles, elevation and windage markings are valid at every magnification setting, providing precise hold and reference points. The daylight visible center dot is visible under the harshest light. Bold, pointed lines draw the eye to the center of the target.

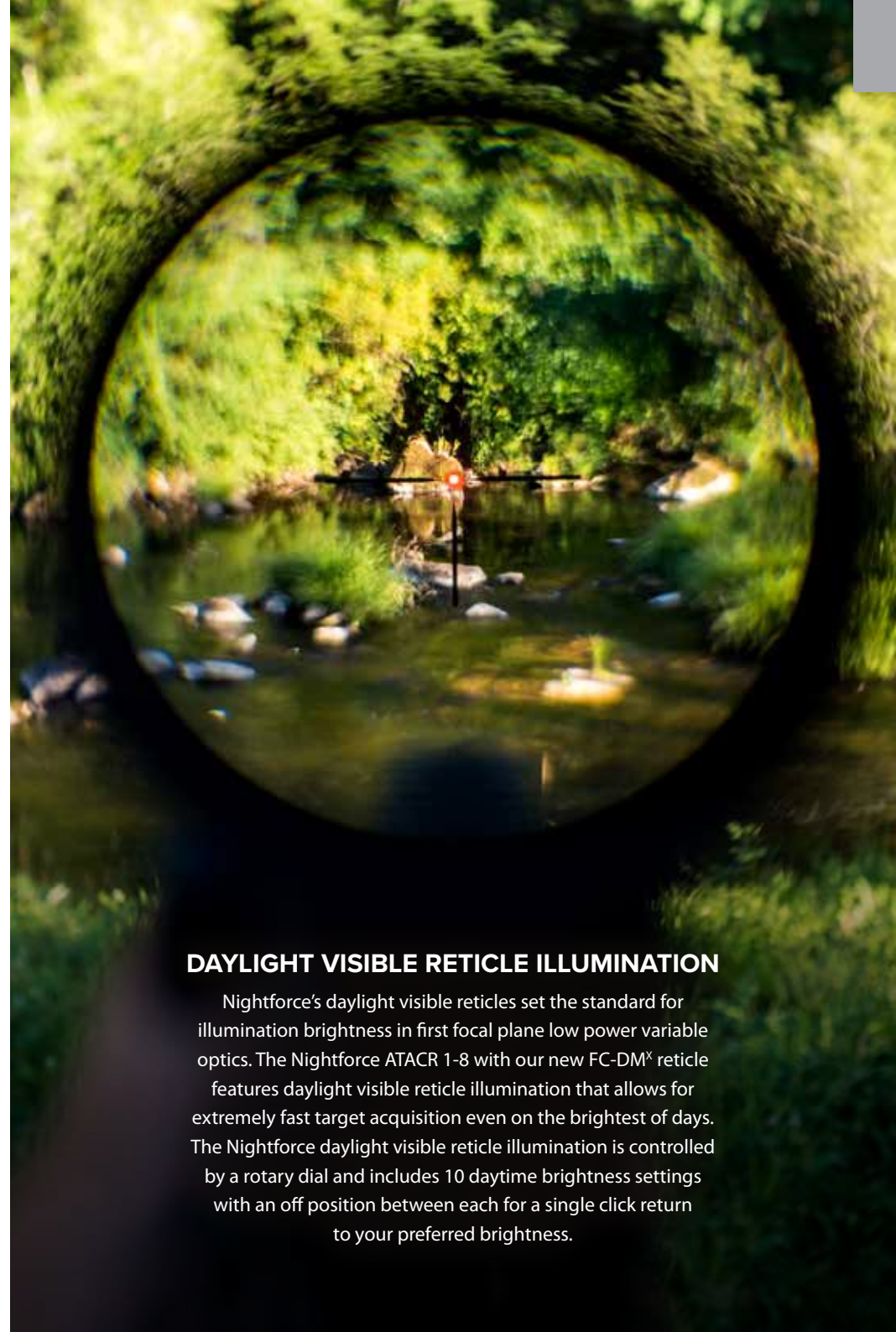
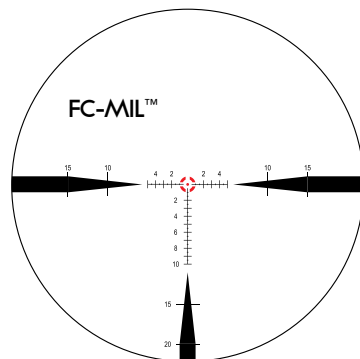

DAYLIGHT VISIBLE RETICLE ILLUMINATION

Nightforce's daylight visible reticles set the standard for illumination brightness in first focal plane low power variable optics. The Nightforce ATACR 1-8 with our new FC-DM^x reticle features daylight visible reticle illumination that allows for extremely fast target acquisition even on the brightest of days. The Nightforce daylight visible reticle illumination is controlled by a rotary dial and includes 10 daytime brightness settings with an off position between each for a single click return to your preferred brightness.

TARGET

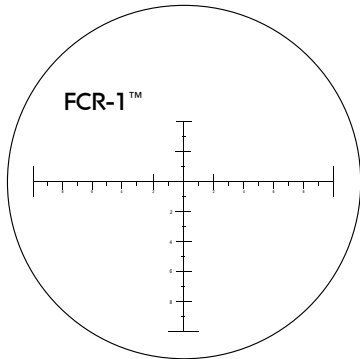

Developed with the help of U.S. F-Class rifle teams. Available in our Competition™ riflescopes.

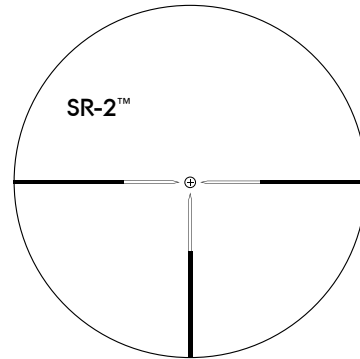

Designed exclusively for our Competition™ SR Fixed 4.5x24, it provides a winning edge at CMP and NRA service rifle matches. The circle and cross reticle is familiar to iron sight shooters.

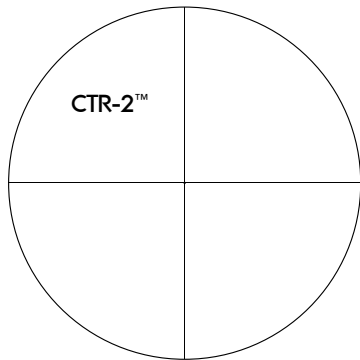

Very fine lines with center dot for target and precision shooting. Competition™ riflescopes only.

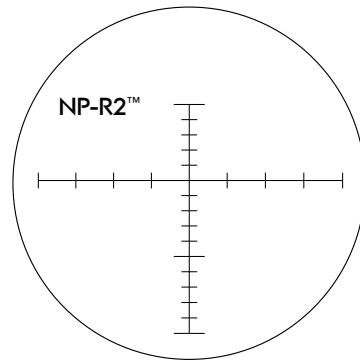

A classic Nightforce MOA reticle, created specifically for long-range applications in our Precision Benchrest models only.

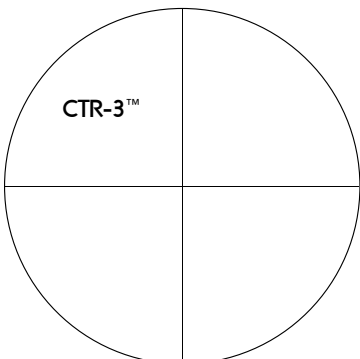

The simplest reticle we offer, having fine .016 MOA lines. Competition™ riflescopes only.

TARGET

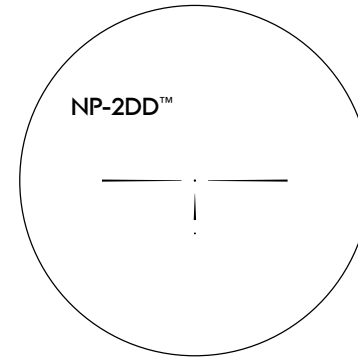

Unobstructed field of view and precise MOA reference markings make the NP-2DD™ ideal for both the varmint hunter and benchrest competitor.

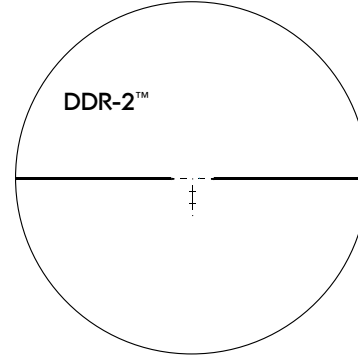

Perfect for the competitor and varmint shooter. .095 MOA center dot, vertical holdover markings. Competition™ riflescopes only.

Please note: Reticles offered in certain Nightforce riflescopes may have minor variations from those pictured here. Some reticles are available only in specific riflescopes.

HUNTING

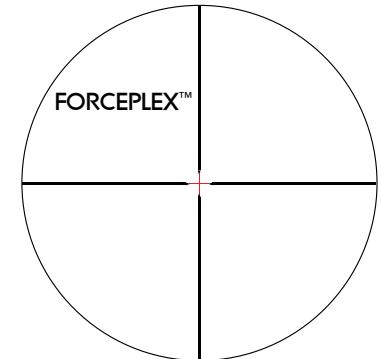

An improvement on traditional fourplex hunting reticles. Clean field of view will not obstruct target. North American markets only.

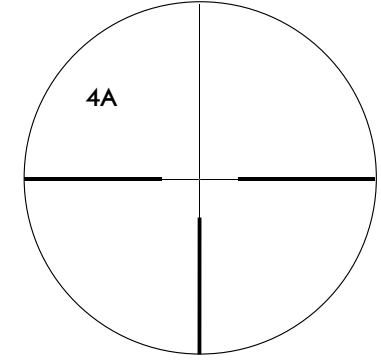

A classic style popular with European hunters for over a century. International markets only.

NIGHTFORCE FEATURES

The Nightforce team is comprised of avid and experienced shooters and hunters. Our passion and creativity fuels Nightforce's development of new technology that makes shooting faster, easier, and more intuitive. Below are just a few of the many innovative features that make a Nightforce, a Nightforce.

ZeroStop[®]

After sighting in your rifle, simply set the ZeroStop[®] according to the instructions, and you create a positive mechanical stopping point at your chosen zero point. No matter how many elevation adjustments you make, turning the elevation dial down to the ZeroStop[®] setting returns you to your original zero, completely by feel.

ZeroSet[™]

Created for our SHV[™] 5-20 x 56 and 4-14 x 50 F1 riflescopes. It provides a quick and efficient means of returning to your zero setting, even after you've made several elevation adjustments.

ZeroHold[™]

A low-profile mechanism utilized on the ATACR[™] 4-16x42 F1. It holds the elevation turret at zero until the ZeroHold[™] button is depressed. It allows a rapid return to zero after making elevation adjustments, and also lets the shooter dial below zero.

DigiIllum[™]

Digital reticle illumination technology is available in many of our riflescopes. Choose the appropriate illumination setting for your lighting conditions—either red or green, in multiple intensities.



All Nightforce riflescopes
are rated for use with .50 BMG rifles.

ACCESSORIES

Nightforce goes to tremendous lengths to make Rugged, Reliable, Repeatable riflescopes. However, the performance of our riflescopes is only as good as the Rings or Mounts holding the riflescope and the base attaching it to the firearm. Heavy recoil, rough handling, and harsh environments can cause issues with poor quality mounting components.

Nightforce Rings, Mounts, Bases, and Accessories are designed and built to Nightforce's demanding standards of precision for those looking to maximize the performance of their riflescope.



X-TREME DUTY™

The Nightforce X-Treme Duty line are our most rugged and advanced Rings, Mounts, and Bases. A combination of Steel, Aluminum, and Titanium materials are machined to precise tolerances, producing a lightweight and strong mounting system that ensures the riflescope is not subjected to stress, strain, or bending as the ring screws are tightened.

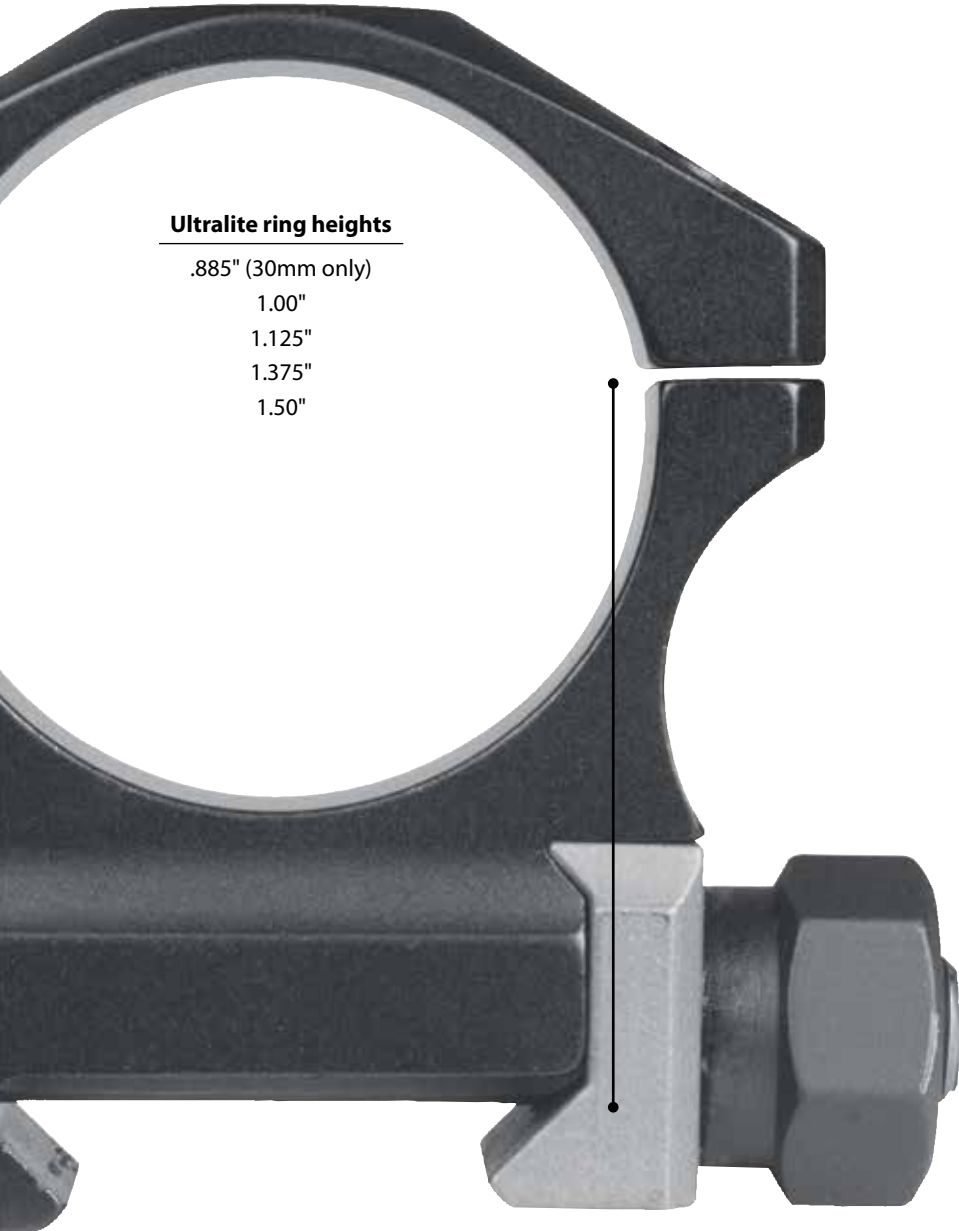

X-TREME DUTY™ ULTRALITE™ RINGS

Available in four-and six-screw versions. Machined 7075-T6 hard anodized aluminum with titanium crossbolts and jaw provide the performance of steel at half the weight. Six-screw rings give 50% more clamping force.



X-TREME DUTY™ STEEL BASE

Precision machined to exact MIL-STD 1913 specification rail dimensions from a single billet of steel, they match the receiver contour ensuring true alignment. Rem 700 and Win 70 bases include an integral recoil lug which provides a precise fit, prevents movement and reduces recoil stress on mounting screws. Standard with a 20 MOA taper, with a 40 MOA taper available for Rem 700 bases.



STANDARD DUTY BASES

Nightforce Standard Duty bases are a quality, affordable solution for ensuring that your scope is firmly mounted to your rifle. These aluminum bases are machined to MIL-STD 1913 rail specifications and hard anodized. Available for a wide variety of firearms, including: Howa 1500, Remington 700, Savage Round Action, Tikka T3, Weatherby MkV.



30mm Ultralite™ Four-Screw



30mm Ultralite™ Six-Screw



34mm Ultralite™ Four-Screw



34mm Ultralite™ Six-Screw

X-TREME DUTY UNIMOUNT AND MAGMOUNT

One-piece mounts have long been popular on semi-automatic platforms like the AR-15/ AR-10 and have been growing in popularity on bolt action rifles. The Nightforce

Unimount™ and Magmount™ feature a CNC machined 7075-T6 hard anodized aluminum body and titanium crossbolts and jaws that are designed to be mounted to firearms with a MIL-STD 1913 rail. This unique design and construction provides the performance of steel at half the weight.

The Nightforce Unimount™ features a cantilever design that allows the scope to be mounted further forward than the rail length would typically allow. The Unimount™ design is particularly useful on AR-15, AR-10, and other semi-automatic rifles with a short receiver rail. A Service Rifle Unimount™ is also available that has additional cantilever when further eye relief is needed.

Unimount™

30mm / 1.125" height / 20 MOA
30mm / 1.375" height / 20 MOA
30mm / 1.5" height / 0 or 20 MOA
34mm / 1.44" height / 20 MOA
34mm / 1.5" height / 0 or 20 MOA



Press-fit crossbolts provide rock-solid security on MIL-STD 1913 receivers.

The Magmount™ and Compact Magmount™ allow clearance of 56mm objective riflescopes on rifles with continuous rails. The third crossbolt adds greater stability against the heavy recoil found on professional and competition bolt action rifles.



Magmount™

30mm / 1.375" height / 0 MOA
34mm / 1.44" height / 0 MOA

Compact Magmount™

34mm / 1.5" height / 0 or 20 MOA



MULTIMOUNT™

Originally designed as a platform for close-range sights to be mounted in conjunction with a primary riflescope. In practice, the MultiMount offers a user-configurable system that is rock solid for nearly any MIL-STD 1913 compatible accessory. Designed to fit 4- and 6-screw X-Treme Duty™ rings. Two MIL-STD 1913 rails included that can mount at 10, 12, and 2 o'clock.



TOP RING BUBBLE LEVEL

Replaces the top ring of our 30mm and 34mm Unimount™, Magmount™ and Ultralite™ rings.



Top ring Bubble Level shown installed.

NIGHTFORCE TOOL KIT

The 10-piece Nightforce Tool Kit includes high-quality torque limiters, bits and drive tools in a zippered storage case that fits nicely in a range bag. Easily adjust mounting screws and components to recommended torque settings, which ensures your scope will stay in place during use, and prevents over-tightening which can damage scopes and affect accuracy.



NIGHTFORCE CLEANING KIT

The 12-piece Nightforce Cleaning Kit comes packed in a handy carrying case. It includes everything you need plus instructions for proper care and cleaning of fine optics.



FLIP-UP LENS CAPS, LENS COVERS, AND SUNSHADES

Sunshades reduce glare, while lens covers and lens caps provide maximum protection from damage and the elements.



WEDGE PRISM

The Nightforce Wedge Prism is designed for shooting at ranges that exceed the elevation travel of the riflescope. The Wedge Prism optically shifts the incoming image to the riflescope by a precise elevation value, which directly adds to the available elevation travel of the system.



The Wedge Prism is offered in either 50MOA/14.5MRAD or 100MOA/29MRAD of optical shift. Each individual unit is measured and labeled with the exact optical shift for repeatable precision. If more travel is needed, two prisms can be mounted in line to create an optical shift equal to the sum of their individual, marked values.

A quick detach mount provides a tool-less and repeatable attachment to a MIL-STD 1913 rail in front of the riflescope. The Wedge Prism is designed for use with scopes mounted in 1.5in (± 0.125 in) rings/mounts and a rail/mount taper up to 60MOA.





SPOTTING SCOPES

Spotting scopes are an essential tool for rifle shooters. For hunters, being able to identify an animal at extreme distances can mean the difference between finding your trophy and walking miles for nothing. For target shooters, a spotting scope provides the resolution needed to both distinguish the score of a round on a paper target and the ability to read wind conditions at multiple distances.

Nightforce Spotting Scopes provide the same standard of quality, resolution, clarity, and color that you love in your Nightforce riflescope in the larger, more powerful, spotting scope design.

SPOTTING SCOPES

TS-82™ Xtreme Hi-Def™ 20-70x

The TS-82™ Xtreme Hi-Def™ 20-70x spotting scope meets, and exceeds the quality, resolution, brilliance, and fidelity of the world's most well-known European spotting scopes, many of which come with much higher price tags.

Our HD fluorite glass provides the truest, most brilliant color and razor-sharp resolution.



Magnification range	20-70x
Objective diameter	82mm
Lens coatings	Fully broadband multi-coated
Main body material	Magnesium alloy
Eyepiece outer diameter	1.87"/47.5mm (1.89"/48mm eyecup dia)
Weight	63.0 oz/1786 g
Waterproof	Yes
Nitrogen purged	Yes
Focus	Barrel
Focus rotations, 6 m to ∞	1 3/4 turns

Eyecup	Twist-up, removable
Tripod platform	Magnesium
Armoring	Full rubber
Protective caps	Eyepiece and objective lens covers
Tripod thread	1/4-20
Exit pupil	20x: 4.1 mm 70x: 1.2 mm
Eye relief	0.7 in/18 mm
Field of view @ 100 yd/m	20x: 12.3 ft/4.1 m 70x: 4.9 ft/1.6 m

SPOTTING SCOPE ACCESSORIES

CARRYING CASE

Carries your spotting scope and accessories. Available individually or as a kit that includes spotting scope, eyepiece, protective sleeve, cleaning kit, fob lens cloth, and grommet kit.



HEAVY-DUTY SLEEVES

Add protection to your spotter without compromising functionality.



MIL-STD 1913 RAIL

Allows attachment of a wide range of accessories to the TS-82 spotting scope.



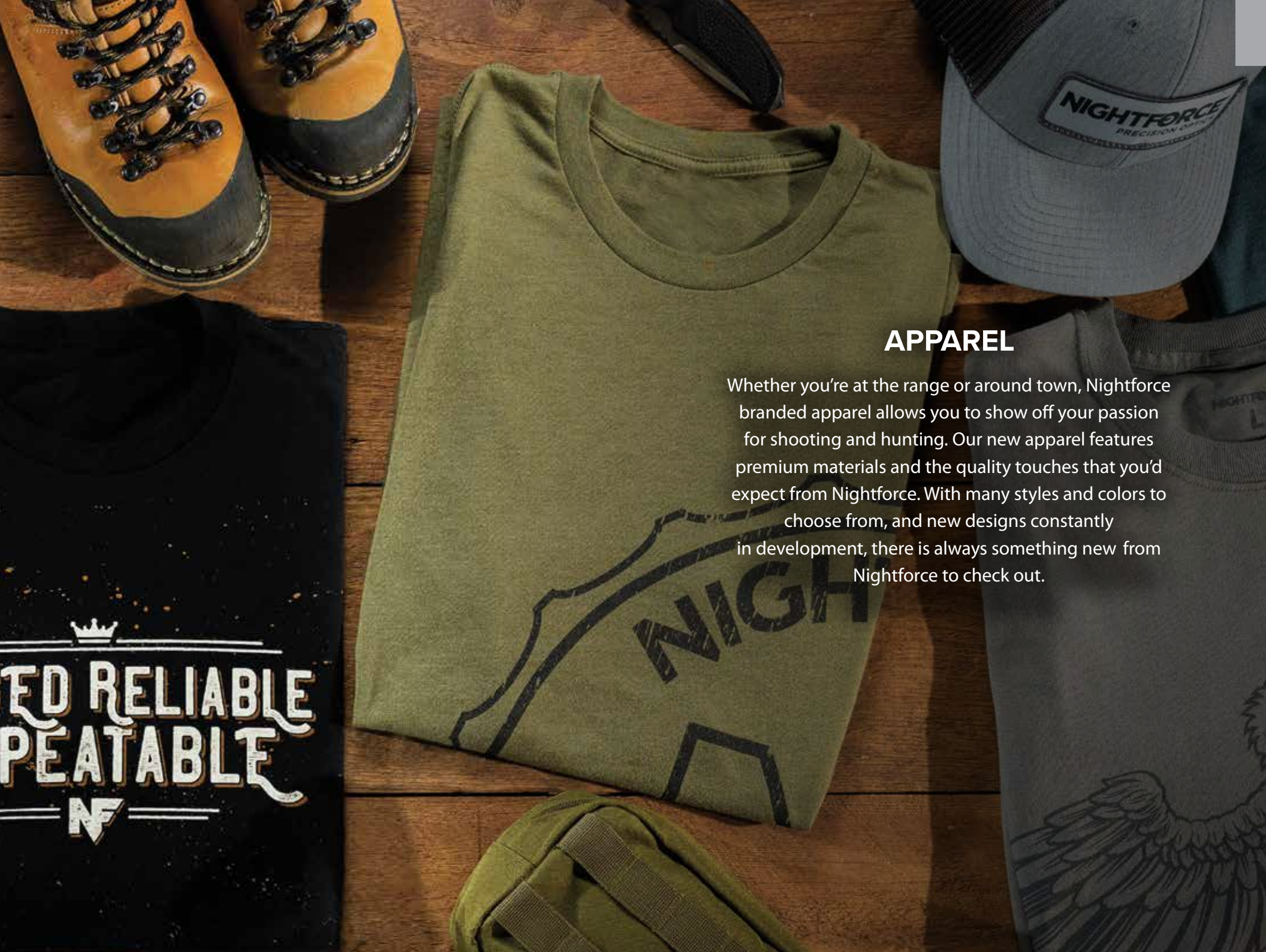

APPAREL

Whether you're at the range or around town, Nightforce branded apparel allows you to show off your passion for shooting and hunting. Our new apparel features premium materials and the quality touches that you'd expect from Nightforce. With many styles and colors to choose from, and new designs constantly in development, there is always something new from Nightforce to check out.

TESTED RELIABLE
REPEATABLE
NF



T-SHIRTS

Soft and comfortable triblend T-shirts perfect for the range or around town. Available in many designs and colors for both men and women.



NEW

LONG SLEEVE T'S

A comfortable unisex long sleeve t-shirt that is perfect fit for any occasion, not just cold weather. Available in a wide range of colors and sizes.

NEW

HOODIES

Performance hoodies in both full zip and pullover. The fit is comfortable for both men and women, with multiple sizes and colors offered.



NEW

FLEX FLEECE

A flex fleece jacket with moisture-wicking technology. Available in both ladies and mens styling.





NEW

CLASSIC HAT

You can never go wrong with these classic Nightforce hats. They feature an adjustable leather strap back with a branded metal clip for a custom fit.



NEW

7 PANEL HAT

A premium embroidered hat that fits perfect and looks good with anything. Features snap back adjustable sizing.



NEW

3D LOGO CLASSIC HAT

3D embroidered Nightforce logo with branding underneath the brim. Features an adjustable leather strap back with a branded metal clip for a custom fit.





NIGHTFORCE MIL-SPEC

**RUGGED. RELIABLE. REPEATABLE.
MISSION AFTER MISSION. OPERATION AFTER OPERATION.**

Nightforce MIL-SPEC riflescopes are built and tested to standards beyond our commercial riflescopes to ensure utter reliability and performance in a combat environment. Each MIL-SPEC riflescope undergoes a battery of tests to validate compliance with the required components of MIL-STD 810G. Most testing is performed to validate performance in extreme temperature and pressure conditions used to simulate combat dive and combat jump operations. We understand the cost of failure for our end users, which prompts the increased testing needed to ensure Nightforce MIL-SPEC products perform at their best in a combat theater.



“After countless hours of refinement, precision in design and perfection in assembly have been achieved. Nightforce is proud to have earned type classifications for the USSOCOM contract variants of our ATACR 1-8x24 F1 (SU-294/PVS), ATACR 4-20x50 F1 (SU-303/PVS), ATACR 5-25x56 F1 (SU-295/PVS), and ATACR 7-35x56 F1 (SU-296/PVS). Providing superior product to military groups has always been a cornerstone to Nightforce. Past, present, and future, we will always ensure that our MIL-SPEC users have the kit they need for the task at hand.”

Klaus Johnson
Vice President, Engineering

NIGHTFORCE MIL-SPEC RIFLESCOPES (“M” PREFIX PART NUMBERS) ARE NOT SOLD ON THE COMMERCIAL MARKET. ADDITIONALLY, NIGHTFORCE OFFERS CUSTOM CONFIGURATIONS TO MEET THE UNIQUE NEEDS OF THE PROFESSIONAL END USER. PLEASE CONTACT THE NIGHTFORCE MIL-GOV-LE DEPARTMENT FOR MORE INFORMATION.



По вопросам продаж и поддержки обращайтесь:

Алматы (7273)495-231
Архангельск (8182)63-90-72
Астрахань (8512)99-46-04
Барнаул (3852)73-04-60
Белгород (4722)40-23-64
Брянск (4832)59-03-52
Владивосток (423)249-28-31
Волгоград (844)278-03-48
Вологда (8172)26-41-59
Воронеж (473)204-51-73
Екатеринбург (343)384-55-89
Иваново (4932)77-34-06
Ижевск (3412)26-03-58
Иркутск (395)279-98-46
Россия (495)268-04-70

Казань (843)206-01-48
Калининград (4012)72-03-81
Калуга (4842)92-23-67
Кемерово (3842)65-04-62
Киров (8332)68-02-04
Краснодар (861)203-40-90
Красноярск (391)204-63-61
Курск (4712)77-13-04
Липецк (4742)52-20-81
Магнитогорск (3519)55-03-13
Москва (495)268-04-70
Мурманск (8152)59-64-93
Набережные Челны (8552)20-53-41
Нижний Новгород (831)429-08-12
Киргизия (996)312-96-26-47

Новокузнецк (3843)20-46-81
Новосибирск (383)227-86-73
Омск (3812)21-46-40
Орел (4862)44-53-42
Оренбург (3532)37-68-04
Пенза (8412)22-31-16
Пермь (342)205-81-47
Ростов-на-Дону (863)308-18-15
Рязань (4912)46-61-64
Самара (846)206-03-16
Санкт-Петербург (812)309-46-40
Саратов (845)249-38-78
Севастополь (8692)22-31-93
Симферополь (3652)67-13-56
Казахстан (7172)727-132

Смоленск (4812)29-41-54
Сочи (862)225-72-31
Ставрополь (8652)20-65-13
Сургут (3462)77-98-35
Тверь (4822)63-31-35
Томск (3822)98-41-53
Тула (4872)74-02-29
Тюмень (3452)66-21-18
Ульяновск (8422)24-23-59
Уфа (347)229-48-12
Хабаровск (4212)92-98-04
Челябинск (351)202-03-61
Череповец (8202)49-02-64
Ярославль (4852)69-52-93